

## **RECALL NOTICE FOR OMNI 1.1 PULLEYS & VARIANTS MADE FEBRUARY 2020 THROUGH OCTOBER 2022**

The button assembly on a limited number of 1.1" Omni Swivel Pulleys and associated variants may not be secure. If the button comes out the side plate can open, allowing the rope to fall out which can result in serious injury or death. It was discovered that a small number of pulleys manufactured from February 2020 through October 2022 may not have had adequate thread locker or sealant, allowing the set screw to back out. Under normal circumstances, either the thread lock or sealant is adequate to secure the button and prevent this issue.

Rock Exotica is issuing a recall for Omni Block 1.1" style pulleys, manufactured from February 2020 through October 2022. These pulleys must be returned to us for inspection / repair.

Rock Exotica is also issuing an inspection notice for all Omni Block style pulleys made from 2018 through October 2022. Pulleys can be inspected by the user / competent person, or if you are not comfortable doing the inspection, you can return it to us for inspection. Inspection criteria is detailed at the end of the document.

Additionally, as a reminder, all products should be inspected before and after each use. For Omni pulleys, the buttons and set screws should be a part of this inspection, along with checking for cracks / deformation / corrosion, the action of the side plate, sheave and swivel eye, bolts, and general condition. Accordingly, we are including supplementary information on checking the button set screws for earlier Omnis made before 2018

### **Recall Notice for Omni 1.1" Pulley Variants, 20050xxx through 22304xxx: Stop Use, Remove from Service & Return to Rock Exotica**

#### **Follow these steps to determine if your Omni Pulley is subject to recall:**

- a) Verify the model number of your Omni Pulley as a 1.1" variant.
- b) Find the serial number on your Omni Pulley.
- c) IF the serial number falls on or within the range of **20050xxx to 22304xxx**, then your Omni Pulley is subject to recall and **must** be returned to Rock Exotica. Follow the instructions on page 4 to return your pulley for inspection or repair.

## Identifying Your Omni Pulley Model

Use the information below to identify your model, matching the correct part number along with the description.

### Rock Exotica 1.1" Omni Variants

Part #, Description

P54	Omni-Block 1.1" (Single)
P54-B	Omni-Block 1.1" (Single/Black)
P54 D	Omni-Block 1.1" (Double)
P54 D-B	Omni-Block 1.1" (Double/Black)
P54 SB-B	Omni-Block 1.1" SwivaBiner Top Single/Black)
P54 D SB-B	Omni-Block 1.1" SwivaBiner Top (Double/Black)

### All other Rock Exotica Omni Models

P51	Omni-Block 1.5" (Single)
P51-B	Omni-Block 1.5" (Single/Black)
P51 SH	Omni-Block 1.5" Shackle Top
P51 SS	Omni-Block 1.5" Stainless Steel Sheave
P51 D	Omni-Block 1.5" (Double)
P51 D-B	Omni-Block 1.5" (Double/Black)
P53	Omni-Block 2.0" (Single)
P53-B	Omni-Block 2.0" (Single/Black)
P53 D	Omni-Block 2.0" (Double)
P53 D-B	Omni-Block 2.0" (Double/Black)
P55	Omni-Block 2.6" (Single)
P55-B	Omni-Block 2.6" (Single Black)
MHP55	Omni-Rigging Block 2.6"
MHP58	Omni-Rigging Block 4.5"

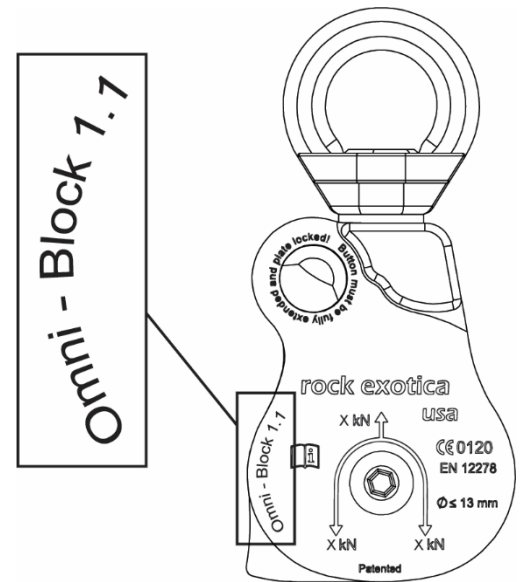

**1.1" P54~ Prefix**

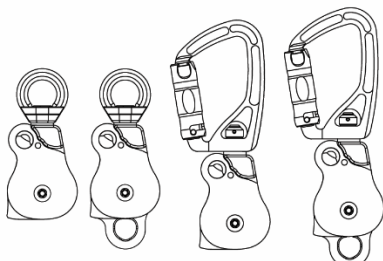

**1.5" P51~ Prefix**

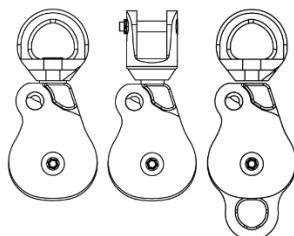

**2.0" P53~ Prefix**

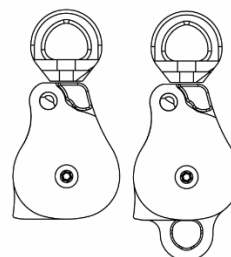

**2.6" MHP~ Prefix  
P55 ~ Prefix**

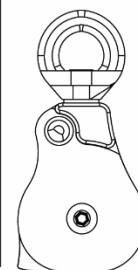

## Identifying Your Serial Number

### Recall dates

The Recall dates span from February 2020 through October 2022 for the 1.1" Omni Pulley. The serial numbers that correspond are:

**20050xxx to 22304xxx**

\*If you have any questions about whether your serial number falls within this period, please contact us at [recall@rockexotica.com](mailto:recall@rockexotica.com)

### Serial Number Format

**2 2 0 0 1 X X X X X**

DAY of manufacture

YEAR of manufacture

### Various Locations of Serial Number:

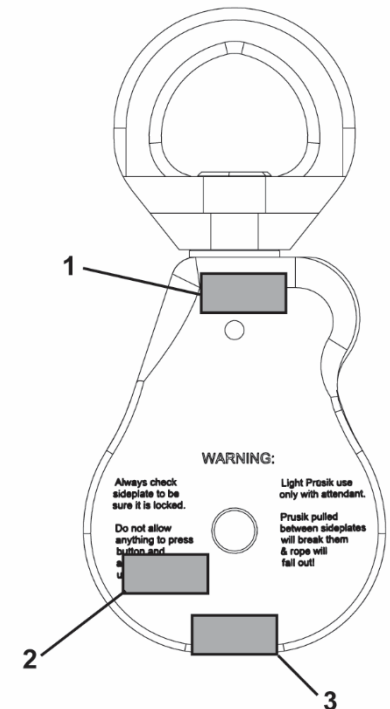

## Returning Your Omni for Repair

Depending on your location, processing your Omni Pulleys for repair will take place directly with Rock Exotica, or with our worldwide network of authorized distributors. If you are located outside the US, please find the distributor closest to you and click on the **Online Return** link to return your equipment for inspection. The distributor handling the inspection / repair is listed next to the region or country below:

### United States

Online Return Form: [www.rockexotica.com/omni-recall](http://www.rockexotica.com/omni-recall)

Contact Email: [recall@rockexotica.com](mailto:recall@rockexotica.com)

### Canada – TNT WorkNRescue

[Online Return Form: Canada](#)

## CENTRAL & SOUTH AMERICA

### Chile – Chile Montaña

[Online Return Form: Chile](#)

### Mexico

[Online Return Form: Mexico](#)

### All Other Countries in Central & South America

[Online Return Form: Latin America](#)

Contact Email: [recall@rockexotica.com](mailto:recall@rockexotica.com)

## EUROPE

### Germany, France, Spain, Italy, Sweden, Hungary, Ireland and Poland

Online Return Form: [GERMAN](#)

Online Return Form: [FRENCH](#)

Online Return Form: [ENGLISH](#)

Contact Email: [recall@rockexotica.de](mailto:recall@rockexotica.de)

(Customers will be returning items through our German Distributor)

### Norway – AAK Safety – [www.aaksafety.no](http://www.aaksafety.no)

[Online Return Form: Norway](#)

### Benelux – Rescue3 Benelux [r3b.eu](http://r3b.eu)

[Online Return Form: Benelux](#)

### United Kingdom

[Online Return Form: UK](#)

For Arborist customers, contact: [Sales@rockexotica.co.uk](mailto:Sales@rockexotica.co.uk) ([www.gustharts.com](http://www.gustharts.com))

For Rope Rescue & Work at Height customers, contact: [sales@r3sargear.com](mailto:sales@r3sargear.com)  
([www.r3sargear.com](http://www.r3sargear.com))

### HAVE QUESTIONS?

We have set up a specific email address, designed for rapid response to your recall-related questions.

We urge you not to call or email other accounts that you may have used for standard customer service in the past, since these are not designed for the scale of specific questions about the Omni Pulleys and returning/repairing them according to the recall.

For the quickest and most direct assistance, please email:

[\*\*recall@rockexotica.com\*\*](mailto:recall@rockexotica.com)

## ASIA

### HONG KONG – Teedo Safety

Contact Email: [jason.xie@teedosafety.com](mailto:jason.xie@teedosafety.com), WeChat: Jasonx2580

### JAPAN – [woodenhandarboriculture@gmail.com](mailto:woodenhandarboriculture@gmail.com)

### KOREA – Denali Company [www.denalicompany.co.kr](http://www.denalicompany.co.kr)

[Online Return Form: Korea](#)

### SINGAPORE – Camper’s Corner [www.camperscorner.com.sg](http://www.camperscorner.com.sg)

[Online Return Form: Singapore](#)

### THAILAND – SeaAirThai [www.seaairthai.com](http://www.seaairthai.com)

### CHINA – Teedo Safety

Contact Email: [jason.xie@teedosafety.com](mailto:jason.xie@teedosafety.com), WeChat: Jasonx2580

### AUSTRALIA – Southern Cross Equipment [www.southerncross.net.au](http://www.southerncross.net.au)

[Online Return Form: Australia](#)

Contact Email: [sales@southerncross.net.au](mailto:sales@southerncross.net.au)

### NEW ZEALAND – Treetools [www.treetools.co.nz](http://www.treetools.co.nz)

[Online Return Form: New Zealand](#)

### INDIA – [www.mtandt.com](http://www.mtandt.com)

[Online Return Form: India](#)

### SOUTH AFRICA – Ropeworkz [ropeworkz.co.za](http://ropeworkz.co.za)

Contact Email: [info@ropeworkz.co.za](mailto:info@ropeworkz.co.za)

### ISRAEL – Lapidot

Contact Email: [info@lapidot.net](mailto:info@lapidot.net)

[Online Return Form: Israel](#)

### DUBAI – TRAKS

[Online Return Form: UAE](#)

If your location is not covered above, contact the dealer or distributor where the product was originally purchased or contact [recall@rockexotica.com](mailto:recall@rockexotica.com) for more information.

## Inspection Notice for Omni Pulleys from 2018 through February 2020: Inspect Before Next Use

### Follow these steps:

- a) Identify the location of the set screw(s) on your Omni Pulley.
- b) Compare the images in the inspection criteria to your pulley.
- c) Follow the inspection instructions to determine if you are required to return your pulleys for additional inspection by Rock Exotica and repair if necessary.

**If you are not comfortable doing the inspection, you may return your device(s) to us and we can perform the inspection for you. See details on returning your device for inspection on page 4.**

## Inspection Evaluation (from 2018 to current)

The inspection criteria below apply to Omni Pulleys manufactured from about 2018 to the current date. The serial number corresponding to this period begins at **18001xxx**.

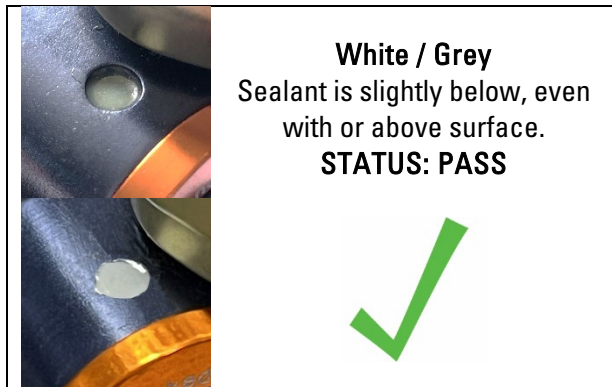
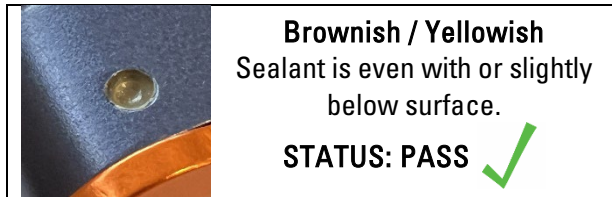

**Set Screw Location**  
is above each button on the Omni

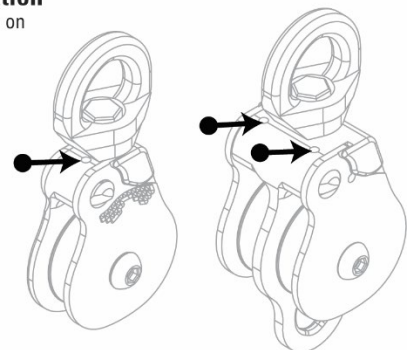

## Inspection Evaluation (prior to 2018)

The inspection criteria below apply to Omni Pulleys manufactured prior to 2016. The serial number corresponding to this period includes all manufacture dates on or prior to **15365xxx**.

Omni-Blocks prior to about 2016 were made in a slightly different manner. The button set screw has thread lock but no sealant on top of it. The correct position of the set screw is the same as all later Omni's – it should be slightly below the surface (see pictures). Inspect and if yours is not below the surface, please return it and we will repair it.

Just like all Omni's, this must be part of the inspection before and after each use.



To make future inspection easier and for extra security, we recommend you add epoxy on top of the set screw. Standard two-part epoxy suitable for metal is available at hardware stores (follow manufacturer's instructions). Simply clean the area of dirt or grease, etc., cover the set screw with epoxy and wipe the excess so the epoxy is about level with the Omni body. A little high or low is okay, but make sure the set screw is covered.

Wait for the epoxy to cure, check that it is hard, and you are done.

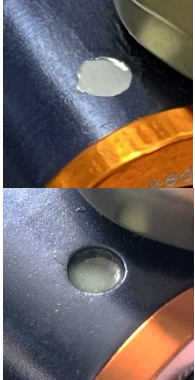

Note: If you are not comfortable doing this yourself, you can send us your Omni and we'll do it and return it to you. See details on returning your device for inspection on page 4.



**Approx. 2016 – 2018**  
**White / Grey**  
Sealant is slightly below, even with or above surface.  
**STATUS: PASS**

**Set screw above surface**  
**STATUS: RETURN**

**2016 & Prior Years**  
Set screw even with surface or slightly below.  
**STATUS: PASS**



**Set Screw Location**  
is above each button on the Omni

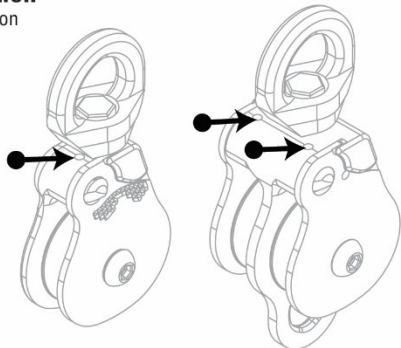

## MHP58-Specific Evaluation

The inspection criteria below refers only to the MHP58, Material-Handling 4.5" Omni, of any date range.

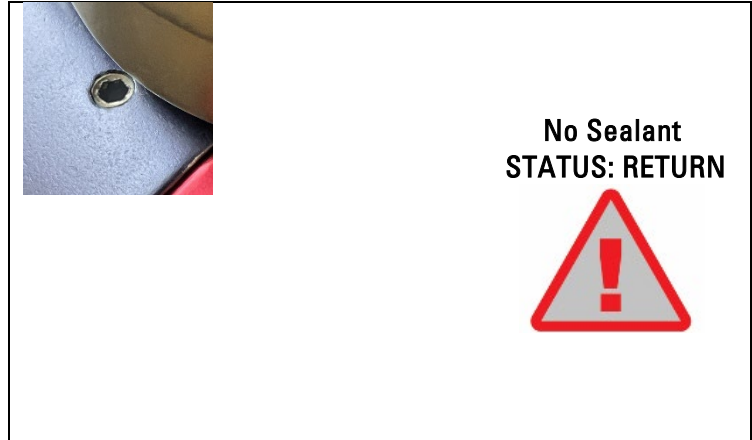
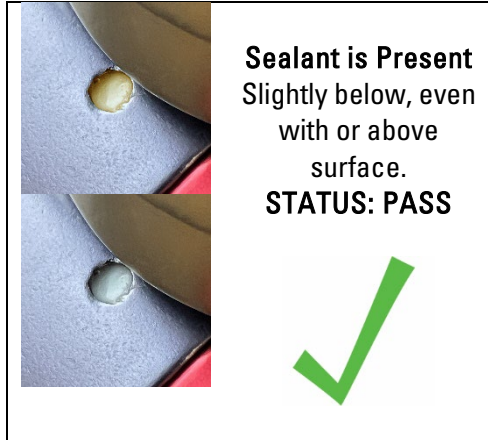

**Set Screw Location**  
is above each button on  
the Omni

